

NetOn

MS-6633 (V1.X) AIO PC

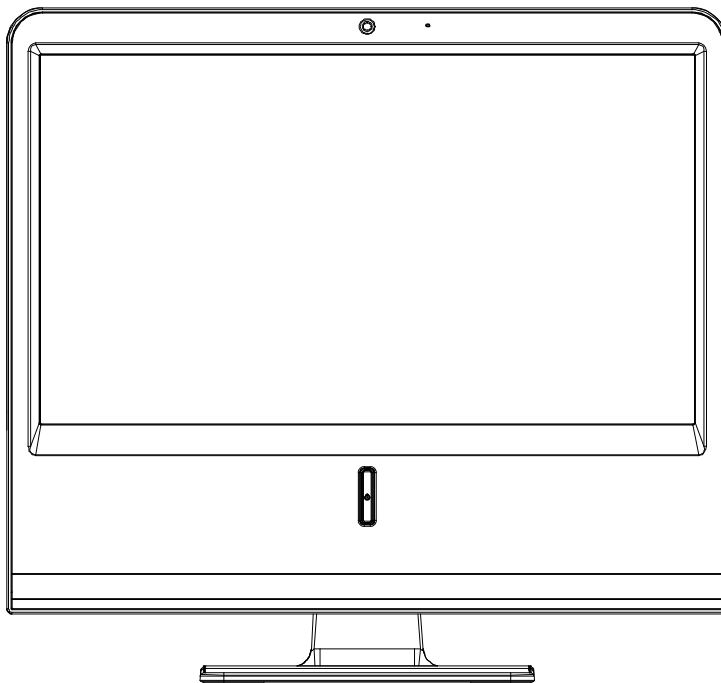

G52-66331X8

Copyright Notice

The material in this document is the intellectual property of **MICRO-STAR INTERNATIONAL**. We take every care in the preparation of this document, but no guarantee is given as to the correctness of its contents. Our products are under continual improvement and we reserve the right to make changes without notice.

Trademarks

All trademarks are the properties of their respective owners.

Intel® and Pentium® are registered trademarks of Intel Corporation.

AMD®, Athlon™, Athlon™ XP, Thoroughbred™ and Duron™ are registered trademarks of AMD Corporation.

NVIDIA®, the NVIDIA logo, DualNet and nForce are registered trademarks or trademarks of NVIDIA Corporation in the United States and/ or other countries.

PS/2® and OS/2® are registered trademarks of International Business Machines Corporation.

Windows® 95/ 98/ 2000/ NT/ XP/ VISTA are registered trademarks of Microsoft Corporation.

Netware® is a registered trademark of Novell, Inc.

Award® is a registered trademark of Phoenix Technologies Ltd.

AMI® is a registered trademark of American Megatrends Inc.

U.S. Patent Numbers

4,631,603; 4,819,098; 4,907,093; 5,315,448; and 6,516,132.

This product incorporates copyright protection technology that is protected by U.S. patents and other intellectual property rights. Use of this copyright protection technology must be authorized by Macrovision, and is intended for home and other limited viewing uses only unless otherwise authorized by Macrovision. Reverse engineering or disassembly is prohibited.

Revision History

Revision	Revision History	Date
V1.2	First Release	June 2009

Technical Support

If a problem arises with your system and no solution can be obtained from the user's manual, please contact your place of purchase or local distributor. Alternatively, please try the following help resources for further guidance.

- ▶ Visit the MSI website for FAQ, technical guide, BIOS updates, driver updates and other information: **<http://global.msi.com.tw/index.php?func=service>**

- ▶ Contact our technical staff at: **<http://ocss.msi.com.tw>**

Safety Instructions

1. Always read the safety instructions carefully.
2. Keep this user's manual for future reference.
3. Keep this equipment away from humidity.
4. Lay this equipment on a reliable flat surface before setting it up.
5. The ventilator on the enclosure is used for air convection and to prevent the equipment from overheating. Do not cover the ventilator.
6. Check the AC input: 100-240V~, 50-60Hz, 1.5A.
7. Check the DC output: 19V  3.42A.
8. Make sure that the power voltage is within its safety range and has been adjusted properly to the value of 100~240V before connecting the equipment to the power inlet.
9. Place the power cord in a way that people are unlikely to step on it. Do not place anything on the power cord.
10. Always unplug the power cord before inserting any add-on card or module.
11. All cautions and warnings on the equipment should be noted.
12. Never pour any liquid into the opening that could damage or cause electrical shock.
13. If any of the following situations arises, get the equipment checked by service personnel:
 - ▶ The power cord or plug is damaged.
 - ▶ Liquid has penetrated into the equipment.
 - ▶ The equipment has been exposed to moisture.
 - ▶ The equipment does not work well or you can not get it work according to user's manual.
 - ▶ The equipment has dropped and damaged.
 - ▶ The equipment has obvious sign of breakage.
14. DO NOT LEAVE THIS EQUIPMENT IN AN ENVIRONMENT UNCONDITIONED, STORAGE TEMPERATURE ABOVE 40°C (102°F), IT MAY DAMAGE THE EQUIPMENT.

WARNING:

1. For every changes in power cord's usage, please use an approved power cord with condition greater or equal to H05VV-F, 3G, 0.75mm².
2. Internal part is hazardous moving parts, please keep fingers and other body parts away.
3. For pluggable equipment, the socket-outlet shall be installed near the equipment and shall be easily accessible.
4. Do not disable the protective earth pin from the plug, the equipment must be connected to an earthed mains socket-outlet.
5. Adjustment of the volume control as well as the equalizer to other settings than the center position may increase the ear-/ headphones output voltage and therefore the sound pressure level.

CAUTION:

Danger of explosion if battery is incorrectly replaced. Replace only with the same or equivalent type recommended by the manufacturer.



廢電池請回收

For better environmental protection, waste batteries should be collected separately for recycling or special disposal.

- | |
|---|
| <ol style="list-style-type: none">1. The optical storage devices are classified as a Class 1 Laser products. Use of controls or adjustments or performance of procedures other than those specified.2. Do not touch the lens inside the drive. |
|---|

FCC-B Radio Frequency Interference Statement

This equipment has been tested and found to comply with the limits for a Class B digital device, pursuant to Part 15 of the FCC Rules. These limits are



designed to provide reasonable protection against harmful interference in a residential installation. This equipment generates, uses and can radiate radio frequency energy and, if not installed and used in accordance with the instruction manual, may cause harmful interference to radio communications. However, there is no guarantee that interference will not occur in a particular installation. If this equipment does cause harmful interference to radio or television reception, which can be determined by turning the equipment off and on, the user is encouraged to try to correct the interference by one or more of the measures listed below:

- ▶ Reorient or relocate the receiving antenna.
- ▶ Increase the separation between the equipment and receiver.
- ▶ Connect the equipment into an outlet on a circuit different from that to which the receiver is connected.
- ▶ Consult the dealer or an experienced radio/television technician for help.

Notice 1

The changes or modifications not expressly approved by the party responsible for compliance could void the user's authority to operate the equipment.

Notice 2

Shielded interface cables and A.C. power cord, if any, must be used in order to comply with the emission limits.

VOIR LA NOTICE D'INSTALLATION AVANT DE RACCORDER AU RESEAU.



This device complies with Part 15 of the FCC Rules. Operation is subject to the following two conditions:

- (1) this device may not cause harmful interference, and*
- (2) this device must accept any interference received, including interference that may cause undesired operation.*

WEEE (Waste Electrical and Electronic Equipment) Statement

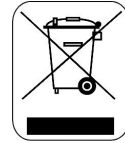

ENGLISH

To protect the global environment and as an environmentalist, MSI must remind you that...

Under the European Union ("EU") Directive on Waste Electrical and Electronic Equipment, Directive 2002/96/EC, which takes effect on August 13, 2005, products of "electrical and electronic equipment" cannot be discarded as municipal waste anymore and manufacturers of covered electronic equipment will be obligated to take back such products at the end of their useful life. MSI will comply with the product take back requirements at the end of life of MSI-branded products that are sold into the EU. You can return these products to local collection points.

DEUTSCH

Hinweis von MSI zur Erhaltung und Schutz unserer Umwelt

Gemäß der Richtlinie 2002/96/EG über Elektro- und Elektronik-Altgeräte dürfen Elektro- und Elektronik-Altgeräte nicht mehr als kommunale Abfälle entsorgt werden. MSI hat europaweit verschiedene Sammel- und Recyclingunternehmen beauftragt, die in die Europäische Union in Verkehr gebrachten Produkte, am Ende seines Lebenszyklus zurückzunehmen. Bitte entsorgen Sie dieses Produkt zum gegebenen Zeitpunkt ausschliesslich an einer lokalen Altgerätesammelstelle in Ihrer Nähe.

FRANÇAIS

En tant qu'écologiste et afin de protéger l'environnement, MSI tient à rappeler ceci...

Au sujet de la directive européenne (EU) relative aux déchets des équipement électriques et électroniques, directive 2002/96/EC, prenant effet le 13 août 2005, que les produits électriques et électroniques ne peuvent être déposés dans les décharges ou tout simplement mis à la poubelle. Les fabricants de ces équipements seront obligés de récupérer certains produits en fin de vie. MSI prendra en compte cette exigence relative au retour des produits en fin de vie au sein de la communauté européenne. Par conséquent vous pouvez retourner localement ces matériels dans les points de collecte.

РУССКИЙ

Компания MSI предпринимает активные действия по защите окружающей среды, поэтому напоминаем вам, что....

В соответствии с директивой Европейского Союза (ЕС) по предотвращению загрязнения окружающей среды использованным электрическим и электронным оборудованием (директива WEEE 2002/96/ЕС), вступающей в силу 13 августа 2005 года, изделия, относящиеся к электрическому и электронному оборудованию, не могут рассматриваться как бытовой мусор, поэтому производители вышеперечисленного электронного оборудования обязаны принимать его для переработки по окончании срока службы. MSI обязуется соблюдать требования по приему продукции, проданной под маркой MSI на территории ЕС, в переработку по окончании срока службы. Вы можете вернуть эти изделия в специализированные пункты приема.

ESPAÑOL

MSI como empresa comprometida con la protección del medio ambiente, recomienda:

Bajo la directiva 2002/96/EC de la Unión Europea en materia de desechos y/o equipos electrónicos, con fecha de rigor desde el 13 de agosto de 2005, los productos clasificados como "eléctricos y equipos electrónicos" no pueden ser depositados en los contenedores habituales de su municipio, los fabricantes de equipos electrónicos, están obligados a hacerse cargo de dichos productos al termino de su período de vida. MSI estará comprometido con los términos de recogida de sus productos vendidos en la Unión Europea al final de su periodo de vida. Usted debe depositar estos productos en el punto limpio establecido por el ayuntamiento de su localidad o entregar a una empresa autorizada para la recogida de estos residuos.

NEDERLANDS

Om het milieu te beschermen, wil MSI u eraan herinneren dat....

De richtlijn van de Europese Unie (EU) met betrekking tot Vervuiling van Electricische en Electronische producten (2002/96/EC), die op 13 Augustus 2005 in zal gaan kunnen niet meer beschouwd worden als vervuiling.

Fabrikanten van dit soort producten worden verplicht om producten retour te nemen aan het eind van hun levenscyclus. MSI zal overeenkomstig de richtlijn handelen voor de producten die de merknaam MSI dragen en verkocht zijn in de EU. Deze goederen kunnen geretourneerd worden op lokale inzamelingspunten.

SRPSKI

Da bi zaštitili prirodnu sredinu, i kao preduzeće koje vodi računa o okolini i prirodnoj sredini, MSI mora da vas podesti da...

Po Direktivi Evropske unije ("EU") o odbačenju elektronske i električne opreme, Direktiva 2002/96/EC, koja stupa na snagu od 13. Avgusta 2005, proizvodi koji spadaju pod "elektronsku i električnu opremu" ne mogu više biti odbačeni kao običan otpad i proizvođači ove opreme biće prinuđeni da uzmu natrag ove proizvode na kraju njihovog uobičajenog veka trajanja. MSI će poštovati zahtev o preuzimanju ovakvih proizvoda kojima je istekao vek trajanja, koji imaju MSI oznaku i koji su prodati u EU. Ove proizvode možete vratiti na lokalnim mestima za prikupljanje.

POLSKI

Aby chronić nasze środowisko naturalne oraz jako firma dbająca o ekologię, MSI przypomina, że...

Zgodnie z Dyrektywą Unii Europejskiej ("UE") dotyczącą odpadów elektrycznych i elektronicznych (Dyrektywa 2002/96/EC), która wchodzi w życie 13 sierpnia 2005, tzw. "produkty oraz wyposażenie elektryczne i elektroniczne" nie mogą być traktowane jako śmieć komunalne, tak więc producenci tych produktów będą zobowiązani do odbierania ich w momencie gdy produkt jest wycofywany z użycia. MSI wypełni wymagania UE, przyjmując produkty (sprzedawane na terenie Unii Europejskiej) wycofywane z użycia. Produkty MSI będzie można zwracać w wyznaczonych punktach zbiorczych.

TÜRKÇE

Çevreci özelliğiyle bilinen MSI dünyada çevreyi korumak için hatırlatır:

Avrupa Birliği (AB) Kararnamesi Elektrik ve Elektronik Malzeme Atığı, 2002/96/EC Kararnamesi altında 13 Ağustos 2005 tarihinden itibaren geçerli olmak üzere, elektrikli ve elektronik malzemeler diğer atıklar gibi çöpe atılmayacak ve bu elektronik cihazların üreticileri, cihazların kullanım süreleri bittikten sonra ürünleri geri toplamakla yükümlü olacaktır. Avrupa Birliği'ne satılan MSI markalı ürünlerin kullanım süreleri bittiğinde MSI ürünlerin geri alınması isteği ile işbirliği içerisinde olacaktır. Ürünlerinizi yerel toplama noktalarına bırakabilirsiniz.

ČESKY

Záleží nám na ochraně životního prostředí - společnost MSI upozorňuje...

Podle směrnice Evropské unie ("EU") o likvidaci elektrických a elektronických výrobků 2002/96/EC platné od 13. srpna 2005 je zakázáno likvidovat "elektrické a elektronické výrobky" v běžném komunálním odpadu a výrobci elektronických výrobků, na které se tato směrnice vztahuje, budou povinni odebírat takové výrobky zpět po skončení jejich životnosti. Společnost MSI splní požadavky na odebírání výrobků značky MSI, prodávaných v zemích EU, po skončení jejich životnosti. Tyto výrobky můžete odevzdat v místních sběrnách.

MAGYAR

Annak érdekében, hogy környezetünket megvédjük, illetve környezetvédként fellépve az MSI emlékezteti Önt, hogy ...

Az Európai Unió („EU”) 2005. augusztus 13-án hatályba lépő, az elektromos és elektronikus berendezések hulladékairól szóló 2002/96/EK irányelve szerint az elektromos és elektronikus berendezések többé nem kezelhetők lakossági hulladékként, és az ilyen elektronikus berendezések gyártói köteleessé válnak az ilyen termékek visszavételére azok hasznos élettartama végén. Az MSI betartja a termékvisszavétellel kapcsolatos követelményeket az MSI márkánév alatt az EU-n belül értékesített termékek esetében, azok élettartamának végén. Az ilyen termékeket a legközelebbi gyűjtőhelyre viheti.

ITALIANO

Per proteggere l'ambiente, MSI, da sempre amica della natura, ti ricorda che....

In base alla Direttiva dell'Unione Europea (EU) sullo Smaltimento dei Materiali Elettrici ed Elettronici, Direttiva 2002/96/EC in vigore dal 13 Agosto 2005, prodotti appartenenti alla categoria dei Materiali Elettrici ed Elettronici non possono più essere eliminati come rifiuti municipali: i produttori di detti materiali saranno obbligati a ritirare ogni prodotto alla fine del suo ciclo di vita. MSI si adeguerà a tale Direttiva ritirando tutti i prodotti marchiati MSI che sono stati venduti all'interno dell'Unione Europea alla fine del loro ciclo di vita. È possibile portare i prodotti nel più vicino punto di raccolta.

CONTENTS

Copyright Notice.....	ii
Trademarks.....	ii
U.S. Patent Numbers.....	ii
Revision History.....	ii
Technical Support.....	ii
Safety Instructions.....	iii
FCC-B Radio Frequency Interference Statement.....	iv
WEEE (Waste Electrical and Electronic Equipment) Statement.....	v
Getting Started.....	1
Mainboard Specifications.....	2
System Specifications.....	3
System Configurations.....	4
Packing Contents.....	12

Getting Started

Congratulations for purchasing the **MSI NetOn AIO PC**. This is your best choice for all in one PC. It can easily be set anywhere. The feature packed platform also gives you an exciting PC experience.

msi[™]

Mainboard Specifications

Processor

- Intel® Atom™ processor N270/ N280 (Optional)
- Front Side Bus (FSB) 533 MHz (N270)/ 667 MHz (N280)
- Thermal Design Power (TDP) 2.5 W
- Highest Frequency Mode (HFM) 1.6 GHz
- Lowest Frequency Mode (LFM) 800 MHz (N270)/ 1 GHz (N280)

Chipset

- North Bridge: Intel® 945GSE chipset
- South Bridge: Intel® ICH7M chipset

Memory

- 1 DDR2 SO-DIMM slot (Non-ECC)
- Supports DDR2 400/ 533 SDRAM (200-Pin/ 1.8 V)

LAN

- Supports Gigabit Ethernet Controller for PCI Express™ Applications by Realtek® RTL8111C
- Compliant with PCI 2.3
- Supports ACPI Power Management

Audio

- Chip integrated by Realtek® ALC888
- Compliant with Azalia 1.0 spec

Form Factor

- 430 mm (W) X 85 mm (H)

System Specifications

LCD Display

- 18.5" TFT LCD display with an optimal resolution of 1366 X 768

Input/ Output (I/O)

- 1 LAN jack
- 1 power jack
- 2 PS/2 ports
- 2 audio jacks
- 4 USB ports

Power Supply

- 65 watt power adapter with active PFC
- Delta/ ADP - 65HB BB
- I/P: 100-240V~, 50-60Hz, 1.5A
- O/P: 19V  3.42A

Stereo Speaker

- 2 internal stereo speakers with 78dB+/-3dB @ 3W

Built-In Card

- 1 WLAN card (Optional)

Built-In Drive

- 1 card reader drive
- 1 optical disk drive (2.5" slim type)
- 1 hard disk drive (2.5" NB type)

Dimension

- 453 mm (W) X 420 mm (H) X 35 mm (D) (with stand)
- 453 mm (W) X 380 mm (H) X 35 mm (D) (without stand)

System Configurations

► Front View

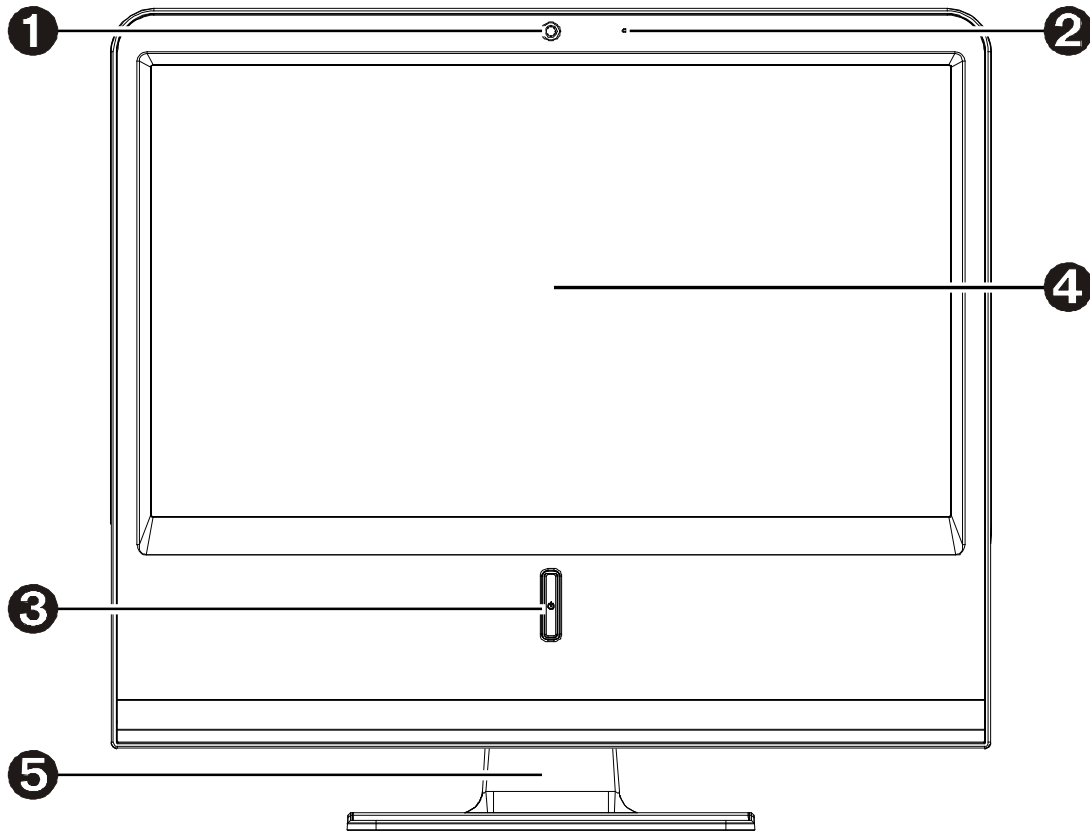

1 Webcam (Optional)

The built-in webcam with the microphone can be used for picture taking, video recording, online conferencing and any other interactive applications.

2 Microphone (Optional)

The built-in microphone can be used for video chatting online.

3 Power Button/ LED

Press the power button to turn the system on and off. The blue power LED is on when you turn on the system; the blue power LED is off when you turn off the system.

4 LCD Display

The 18.5-inch TFT LCD display is with an optimal resolution of 1366 X 768.

5 Stand

► Back View

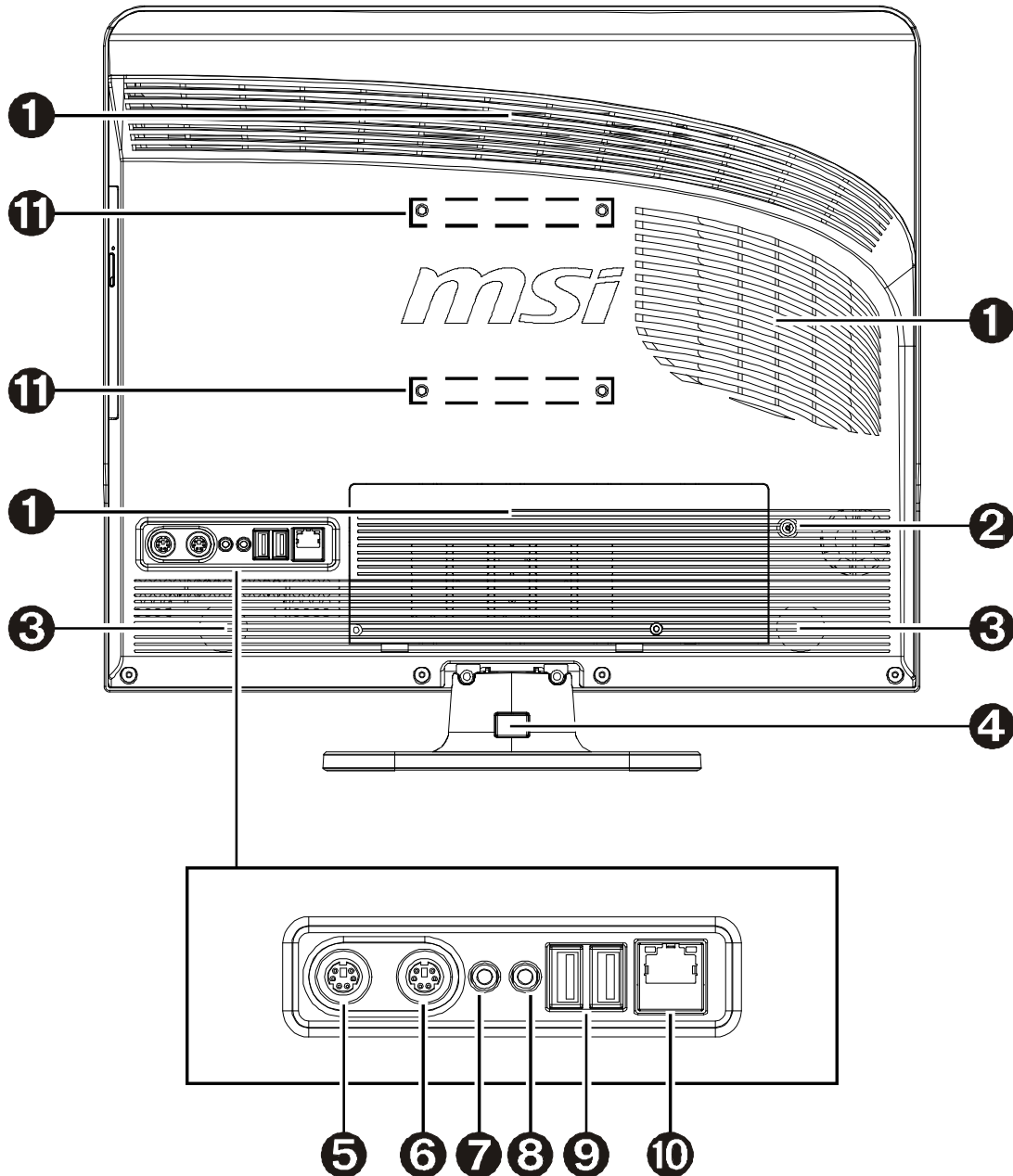

* We suggest that you should connect the power adapter to your AIO PC first and then connect the power cord to the socket-outlet for safety reason.

1 Ventilator

The ventilator on the enclosure is used for air convection and to prevent the equipment from overheating. Do not cover the ventilator.

2 Power Jack

The power adapter converts AC power to DC power for this jack. Power supplied through this jack supplies power to the PC. To prevent damage to the PC, always use the supplied power adapter.

3 Stereo Speakers

The built-in stereo speakers deliver high quality sound blaster with stereo system and Hi-Fi function supported.

4 Release Button (for Stand)

Press the release button to remove the stand.

5 PS/2® Port (Green)

The standard PS/2® mouse DIN connector is for a PS/2® mouse.

6 PS/2® Port (Purple)

The standard PS/2® keyboard DIN connector is for a PS/2® keyboard.

7 Headphone Jack (Green)

This is a connector for headphones or speakers.

8 Microphone Jack (Pink)

This is a connector for microphone.

9 USB Ports

The USB (Universal Serial Bus) port is provided for attaching USB devices such as mouse, keyboard, printer, scanner, camera, PDA or other USB-compatible devices.

10 LAN Jack

The standard RJ-45 LAN jack is provided for connection to the Local Area Network (LAN). You can connect a network cable to it.

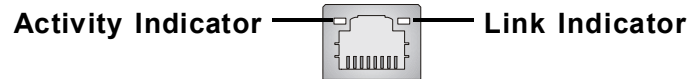

LED	Color	LED State	Condition
Left	Yellow	Off	LAN link is not established.
		On (steady state)	LAN link is established.
		On (brighter & pulsing)	The computer is communicating with another computer on the LAN.
Right	Green	Off	10 Mbit/ sec data rate is selected.
		On	100 Mbit/ sec data rate is selected.
	Orange	On	1000 Mbit/ sec data rate is selected.

11 VESA Mount Hole (Optional)

Please remove the rubber on VESA mount hole to wall mount the AIO PC.

► Side View

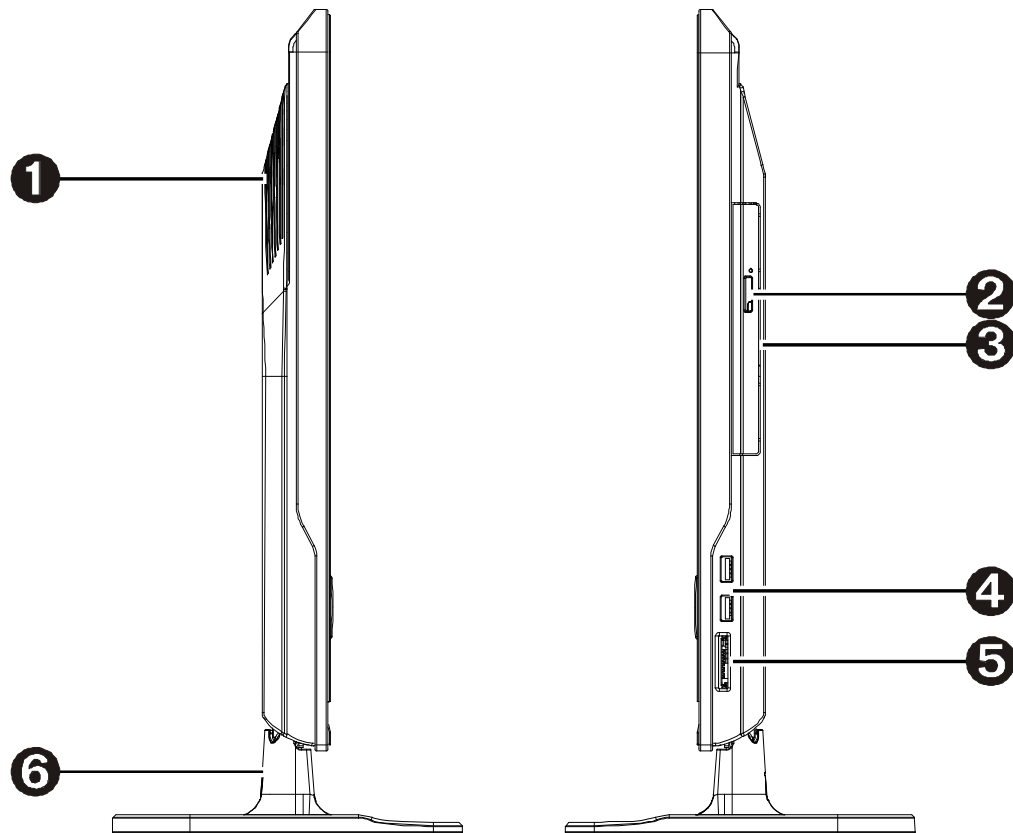

1 Ventilator

The ventilator on the enclosure is used for air convection and to prevent the equipment from overheating. Do not cover the ventilator.

2 Eject Button/ ODD LED 

Press the eject button to open the optical disk drive. The ODD LED is on when CD/ DVD is read from or written to the optical disk drive.

③ Optical Disk Drive

④ USB Ports

The USB (Universal Serial Bus) port is provided for attaching USB devices such as mouse, keyboard, printer, scanner, camera, PDA or other USB-compatible devices.

⑤ Card Reader Drive

The built-in card reader may support various types of memory card, such as XD (eXtreme Digital), SD (Secure Digital), SDHC (SD High Capacity), MS (Memory Stick), MS Pro (Memory Stick Pro) or MMC (Multi-Media Card) cards that usually used in devices like digital cameras, MP3 players, mobile phones and PDAs. Contact the local dealer for further information and please be noted that the supported memory cards may vary without notice.

⑥ Stand (Please follow the steps to install the stand correctly)

Step 1. Place your system horizontally on a reliable flat surface before installation.

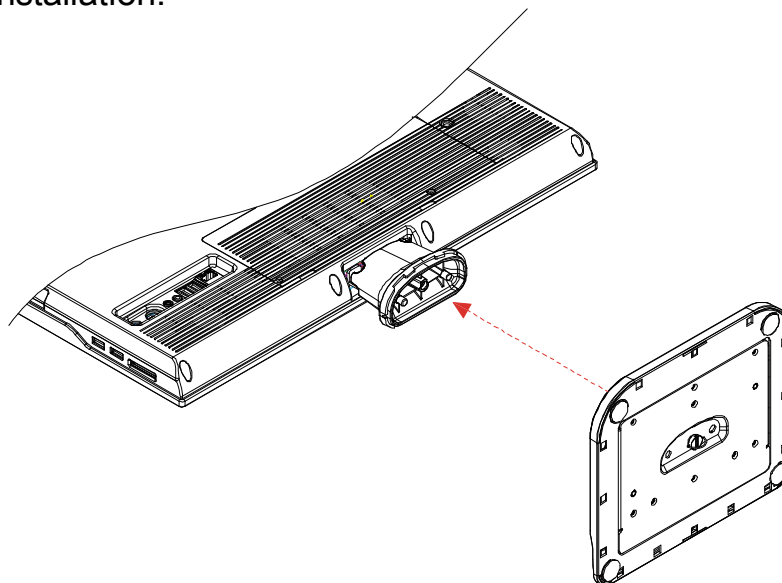

Step 2. Line up the screw holes accordingly to lock the stand with one thumb screw.

Note: There are two different ways to lock this thumb screw.

Way 1 Lock the stand with fingers **Way 2** Lock the stand with a (twist the thumb screw clockwise). flathead screwdriver.

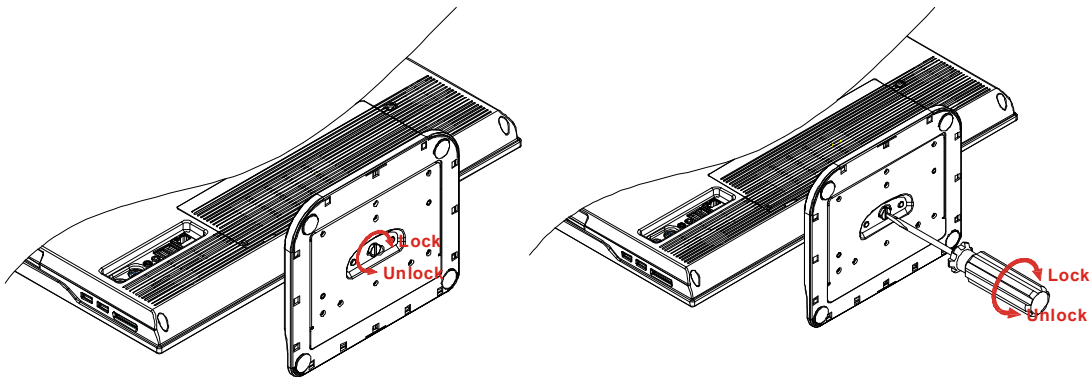

Step 3. Place your system vertically and the installation is finished.

Packing Contents

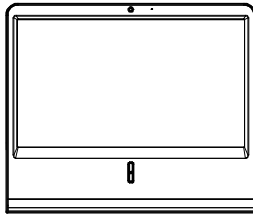

NetOn AIO PC

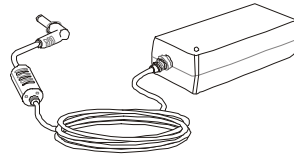

Power Adapter

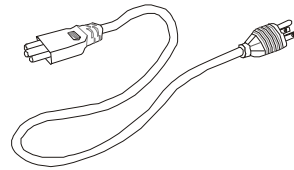

Power Cord

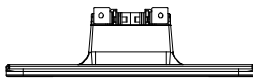

Stand

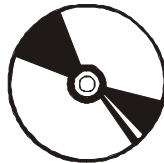

**Driver & Utility
& Blank CD**

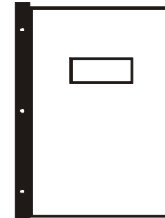

**User Manual &
Quick Guide**



LCD Display Wiper

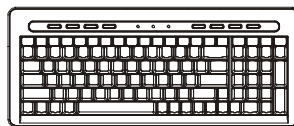

Keyboard (Optional)



Mouse (Optional)

- * *The blank CD is for system recovery backup.*
- * *Please contact us immediately if any of the item is damaged or missing.*
- * *The picture is for your reference only and your packing contents may slightly vary depending on the model you purchased.*